

CANOPUS Gas Station Lighting Fixture

96 W



General Application Areas



Factories



Fuel Stations

General Information

Canopy / Gas Station Lighting Luminaire is a high power luminaire with various lenses designed for ceiling heights up to 6 m. LED modules with high energy efficiency are used in luminaires with a compact chassis structure. It has 90°, 110° angle value options for gas station application. It is also classified according to energy consumption. Gas Station Lighting can be designed and produced by determining different light and power values according to the ceiling height and dimensions of the area to be illuminated.

Optical Beam Angles

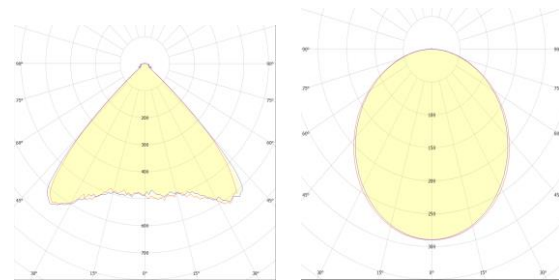

90°

110°

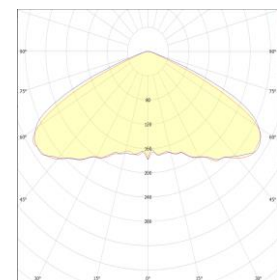

120°

CANOPUS Gas Station Lighting Fixture

96 W

Technical Specifications

Power	:96W
Input Voltage	:200-240 V AC 50/60 HZ
Power Factor	:>0,9
Effectiveness Factor	:132+lm/W
Luminous Flux	:12038lm
Light Angle	:90°/110°/120°
Color Temperature (CCT)	:3000K /4000K/5000K/ 6500K
Color Rendering Index (CRI)	:80+
IP Protection Class	:IP 65 / IP66 (Optional)
Frameless Dimensions	:330mm x 330mm x 75mm
Framed Dimensions	:400mm x 400mm x 120mm
Weight	:7,9 kg
Warranty Period	:5 Years

Optical and Electrical Properties

Body	Aluminum Injection	CE Marking	Yes
Color Options	Black, Gray	RoHS Compliance	Yes
Front Cover	Tempered Glass	Lifetime	≥60.000 Hours
Lens	PMMA	Throttling Options	1-10V, TRIAC, DALI
Light Source	LED	Operating Temperature	-25°/+55°C
Impact Resistance	IK 08- IK 10 (Optional)	Total Harmonic Distortion	<%20

Technical Drawing and Connection Diagram

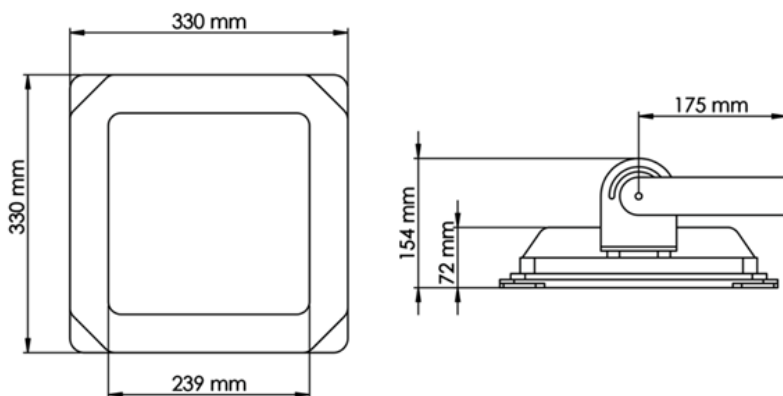

CANOPUS Gas Station Lighting Fixture

96 W

Product Variations

Product Code	Power	Input Voltage	Luminous Flux	Light Angle	Frameless Dimensions	Framed Dimensions	Weight
CNP-072RM-00902-865-9010	72W	200-240 V AC 50/60 Hz	9504 lm	90°	330x330x75 mm	400mm x 400mm x 120mm	7,9 kg
CNP-096RM-00902-865-9010	96W	200-240 V AC 50/60 Hz	12672 lm	90°	330x330x75 mm	400mm x 400mm x 120mm	7,9 kg
CNP-128RM-00902-865-9010	128W	200-240 V AC 50/60 Hz	16896 lm	90°	330x330x75 mm	400mm x 400mm x 120mm	7,9 kg
CNP-072RM-01102-865-9010	72W	200-240 V AC 50/60 Hz	9072 lm	110°	330x330x75 mm	400mm x 400mm x 120mm	7,9 kg
CNP-096RM-01102-865-9010	96W	200-240 V AC 50/60 Hz	12096 lm	110°	330x330x75 mm	400mm x 400mm x 120mm	7,9 kg
CNP-128RM-01102-865-9010	128W	200-240 V AC 50/60 Hz	16128 lm	110°	330x330x75 mm	400mm x 400mm x 120mm	7,9 kg
CNP-072RM-01202-865-9010	72W	200-240 V AC 50/60 Hz	7920 lm	120°	330x330x75 mm	400mm x 400mm x 120mm	7,9 kg
CNP-096RM-01202-865-9010	96W	200-240 V AC 50/60 Hz	10560 lm	120°	330x330x75 mm	400mm x 400mm x 120mm	7,9 kg
CNP-128RM-01202-865-9010	128W	200-240 V AC 50/60 Hz	14080 lm	120°	330x330x75 mm	400mm x 400mm x 120mm	7,9 kg